

Single-chip Type with Built-in FET Switching Regulator Series



# Output 1.0A High-efficiency Step-down Switching regulators with Built-in Power MOSFET

**BU90002GWZ, BU90003GWZ, BU90004GWZ, BU90005GWZ, BU90006GWZ,**

No.11xxxEATxx

## ●Description

The BU9000XGWZ are a high efficiency 6MHz synchronous step-down switching regulator with ultra low current PFM mode.

It provides up to 1.0A load current and an input voltage range from 3.0V to 5.5V, optimized for battery powered portable applications.

BU9000XGWZ has a mode control pin that allows the user to select Forced PWM(Pulse Width Modulation)mode or PFM(Pulse Frequency Modulation) and PWM auto change mode utilized power save operation at light load current.

## ●Features

- 1) 93% peak efficiency
- 2) 4 to 6 MHz switching frequency
- 3) Input voltage  $V_{IN}=2.3V$  to 5.5V(BU90003~BU90006),  $V_{IN}=4.0V$  to 5.5V (BU90002)
- 4) 45uA typical quiescent current
- 5) Fast transient response
- 6) Automatic PFM/PWM operation
- 7) Forced PWM operation
- 8) Internal Soft Start
- 9) Under voltage lockout
- 10) Over current protection
- 11) Thermal shutdown
- 12) Ultra small and low profile WLCSP (1.3mm × 0.9mm t=0.40mm MAX) (UCSP35L1)

## ●Applications

Cell phones, Smart phones, Portable applications and Micro DC/DC modules, USB accessories

## ●Operating range

Part No.	Output voltage	Input voltage
BU90002GWZ	3.30V	4.0V to 5.5V
BU90003GWZ	1.20V	2.3V to 5.5V
BU90004GWZ	1.80V	2.3V to 5.5V
BU90005GWZ	2.50V	2.3V to 5.5V
BU90006GWZ	3.00V	2.3V to 5.5V

## ● Absolute maximum ratings

Parameter	Symbol	Rating	Unit
Maximum input power supply voltage	VIN	7	V
Maximum voltage at EN, FB, LX, MODE	VEN, VFB, VLX, VMODE	7	V
Power dissipation	Pd	0.39(*1)	W
Operating temperature range	Topr	-40 ~ +85	°C
Storage temperature range	Tstg	-55 ~ +125	°C
Junction temperature	Tjmax	+125	°C

(\*1) When mounted on the specified PCB (55mm x 63mm), Deducted by 3.9m W/c when used over Ta=25c

## ● Operating conditions Ta=25c, VIN=3.6V(BU90003GWZ~BU90006GWZ), VIN=5.0V(BU90002GWZ)

Item	Symbol	Rating			Unit	Condition	
		Min.	Typ.	Max.			
<b>【Switching regulator】</b>							
Output voltage accuracy	VOUTA	-2	-	+2	%	MODE:H(PWM Operation)	
		-2	-	+3		MODE:L(PWM/PFM Operation)	
	IoutMax1	-	-	1.0	A	3.0V ≤ VIN < 5.5V	
	IoutMax2	-	-	0.8	A	2.7V ≤ VIN < 3.0V	
	IoutMax3	-	-	0.6	A	2.3V ≤ VIN < 2.7V	
<b>【Soft start】</b>							
Soft start time	Tss	65	120	240	usec		
<b>【Frequency control】</b>							
Switching frequency	fosc	5.4	6.0	6.6	MHz	No load BU90002GWZ, BU90005GWZ BU90006GWZ	
		4.8	5.4	6.0	MHz	No load BU90004GWZ	
		3.6	4.0	4.4	MHz	No load BU90003GWZ	
<b>【Driver】</b>							
PchFET on resistance	RonP1	-	250	400	mOhm	VIN=5.0V	
	RonP2	-	300	450	mOhm	VIN=3.6V	
NchFET on resistance	RonN1	-	220	350	mOhm	VIN=5.0V	
	RonN2	-	250	380	mOhm	VIN=3.6V	
<b>【Control】</b>							
EN pin control voltage	Operation	VENH	1.4	-	VIN	V	
	Non Operation	VENL	0	-	0.4	V	
MODE pin control voltage	Operation	VMODEH	1.4	-	VIN	V	Forced PWM
	Non Operation	VMODEL	0	-	0.4	V	Automatic PFM/PWM
<b>【UVLO】</b>							
Protect threshold voltage	Uvth	1.95	2.05	2.15	V		
Hysteresis	Uvhy	50	100	150	mV		
<b>【Current limit】</b>							
Current limit threshold	ILIMIT	1.5	1.7	1.9	A	PMOS current detect, Open loop	
<b>【Output discharge】</b>							
Output discharge resistance	DRES	55	110	220	Ohm	EN=0V	
<b>【Circuit current】</b>							
Operating quiescent current	IINS	-	45	65	uA	EN:H, MODE:L, VOUT=3.6V forced Not switching	
Shutdown current	SHD	-	0	1	uA	EN=0V	

○ No design for durability against radiation

●Electrical characteristic curves (Reference data)

L:LQM21MPN1R0NG0 (2.0mm × 1.6mm × 1.0mm Murata)  
 COUT:GRM155R60J475M(1.0mm × 0.5mm × 0.5mm Murata)

BU90002GWZ (3.3V OUTPUT)

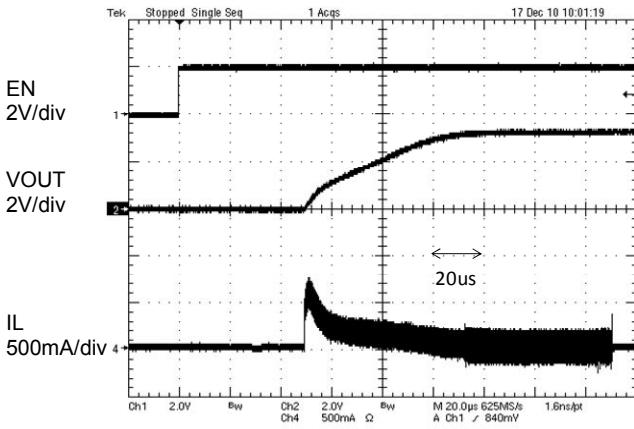

Fig.1 Start up

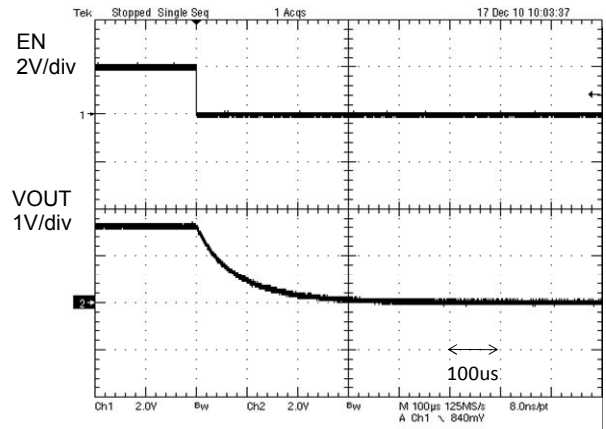

Fig.2 Shut down

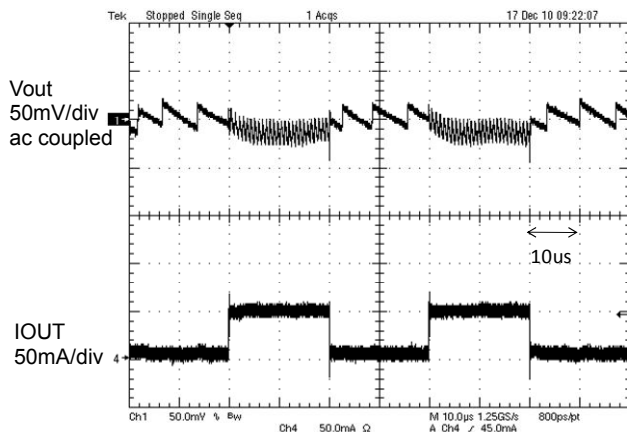

Fig.3 Load transient response 5mA to 50mA  
 $tr=100ns$ , Mode :Low

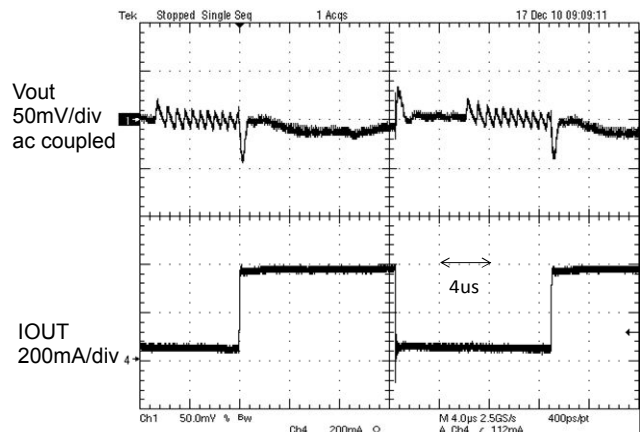

Fig.4 Load transient response 50mA to 350mA  
 $tr=100ns$ , Mode :Low

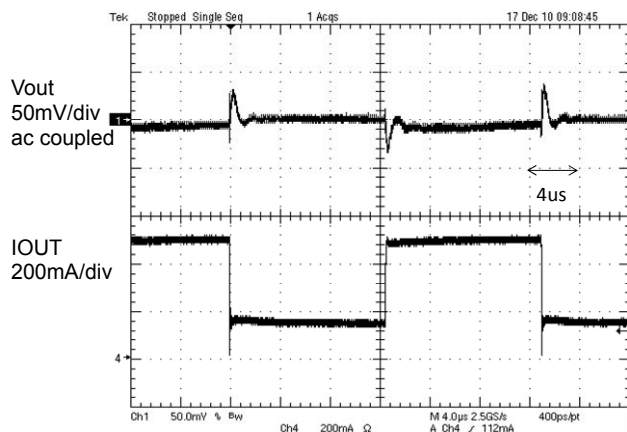

Fig.5 Load transient response 150mA to 500mA  
 $tr=100ns$ , Mode :High

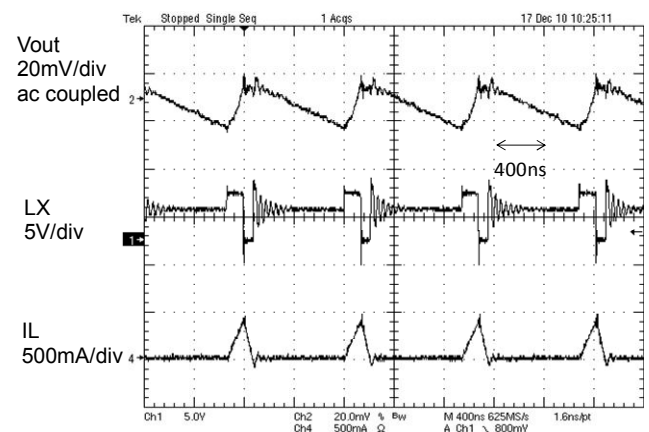

Fig.6 PFM mode Operation  
 $I_{out}=40mA$

●Electrical characteristic curves (Reference data) – Continued  
 BU90002GWZ (3.3V OUTPUT)

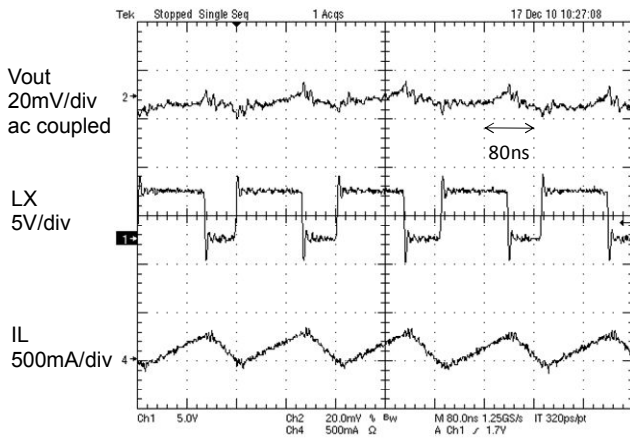

Fig.7 PFM mode Operation  
 $I_{out}=100mA$

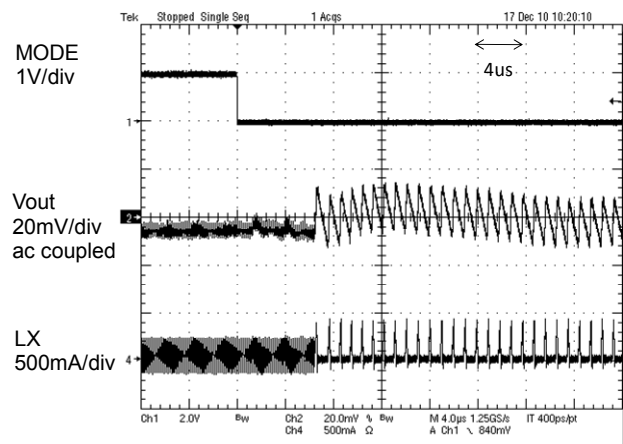

Fig.8 Mode Change Response  
 MODE High to Low

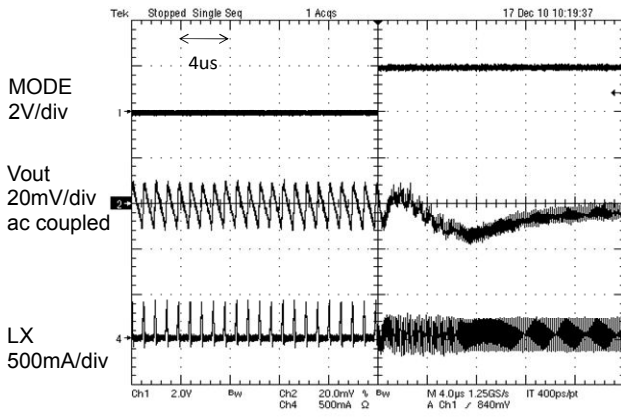

Fig.9 Mode Change Response  
 MODE Low to High

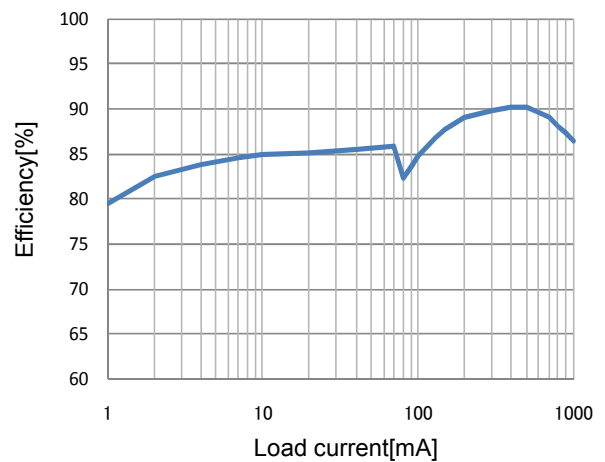

Fig.10 Efficiency vs Load current  
 $V_{IN}=5V$  PWM/PFM Auto Mode

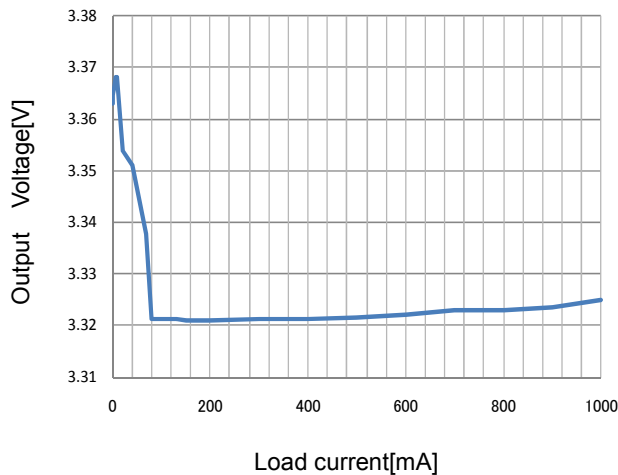

Fig.11 Load regulation  
 $V_{IN}=5V$  PWM/PFM Auto mode

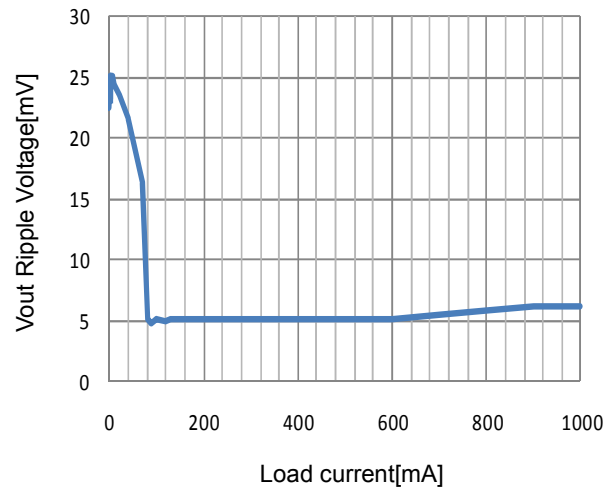

Fig.12 Vout Ripple Voltage  
 $V_{IN}=5V$  PWM/PFM Auto Mode

●Electrical characteristic curves (Reference data)  
BU90003GWZ(1.2V OUTPUT)

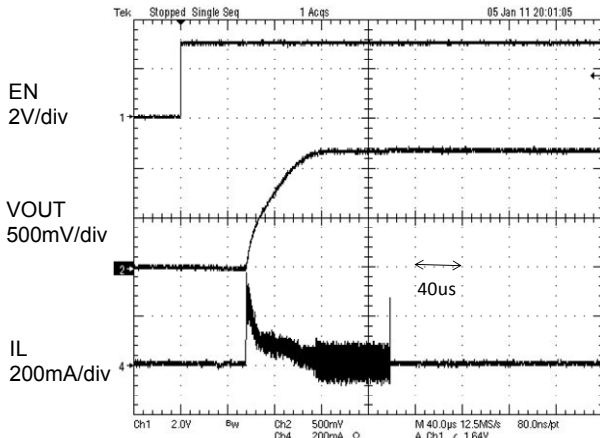

Fig.13 Start up

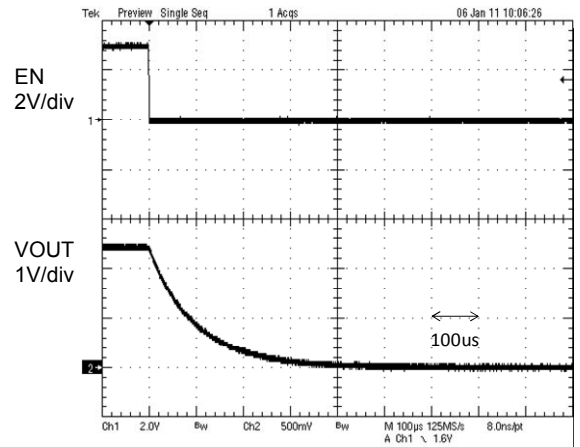

Fig.14 Shut down

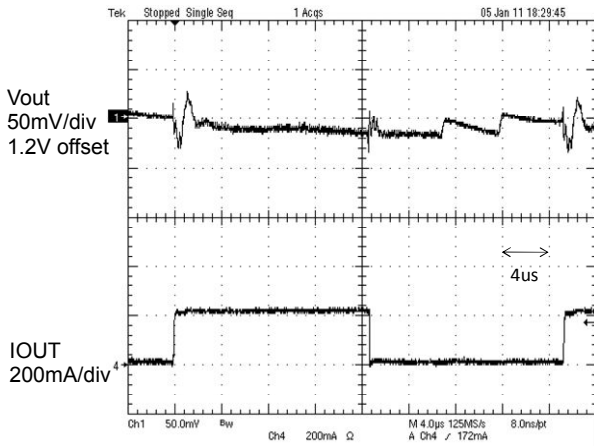

Fig.15 Load transient response 5mA to 200mA  
 $t_r=t_f=100\text{ns}$ , Mode :Low

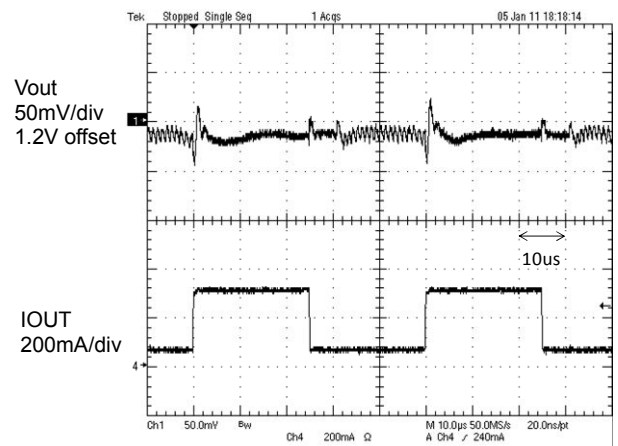

Fig.16 Load transient response 50mA to 350mA  
 $t_r=t_f=100\text{ns}$ , Mode :Low

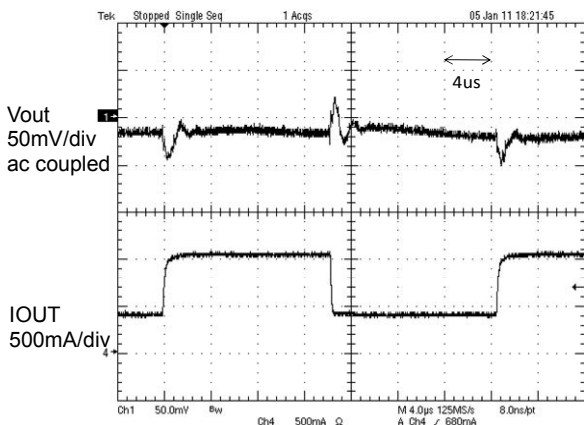

Fig.17 Load transient response 400mA to 1000mA  
 $t_r=t_f=100\text{ns}$ , Mode :Low

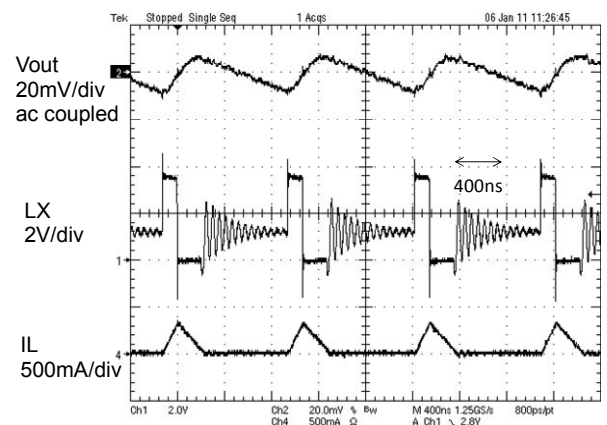

Fig.18 PFM mode Operation  $I_{out}=50\text{mA}$

●Electrical characteristic curves (Reference data) – Continued  
 BU90003GWZ(1.2V OUTPUT)

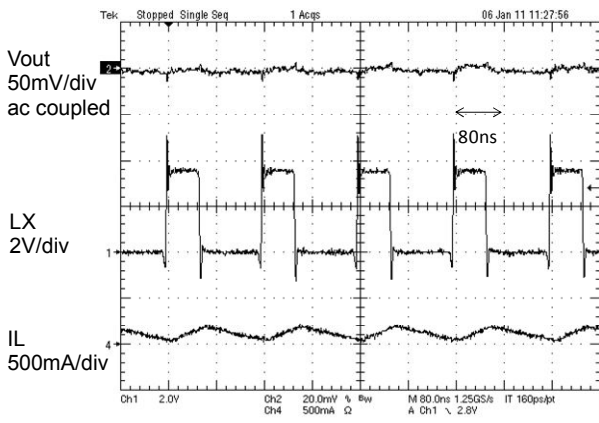

Fig.19 PWM mode Operation Iout=100mA

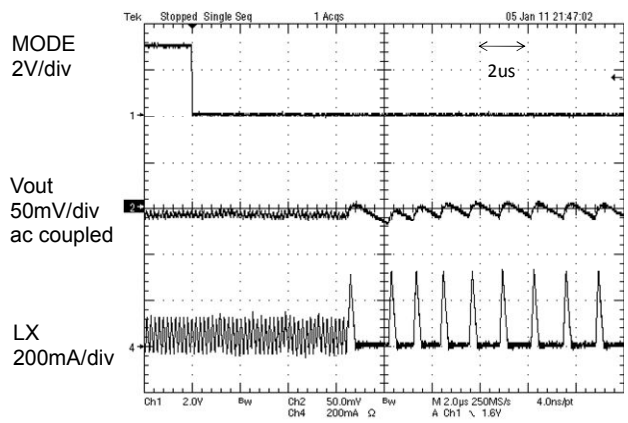

Fig.20 Mode Change Response  
 MODE High to Low

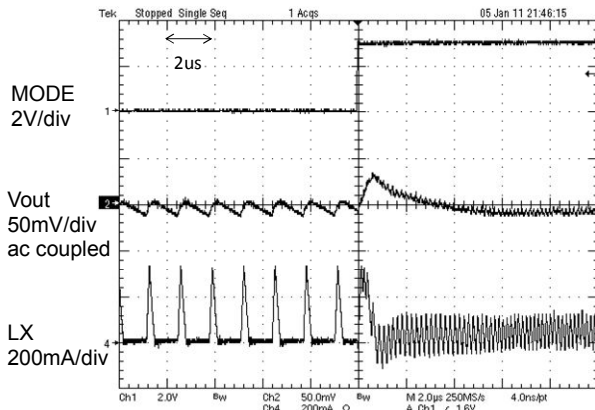

Fig.21 Mode Change Response  
 MODE Low to High

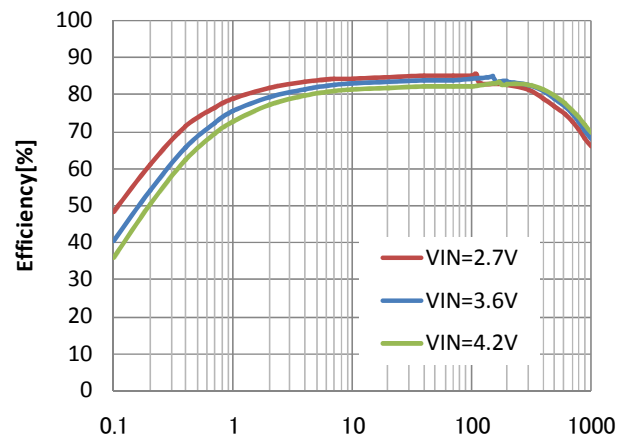

Fig.22 Efficiency vs Load current  
 VIN=3.6V PWM/PFM Auto Mode

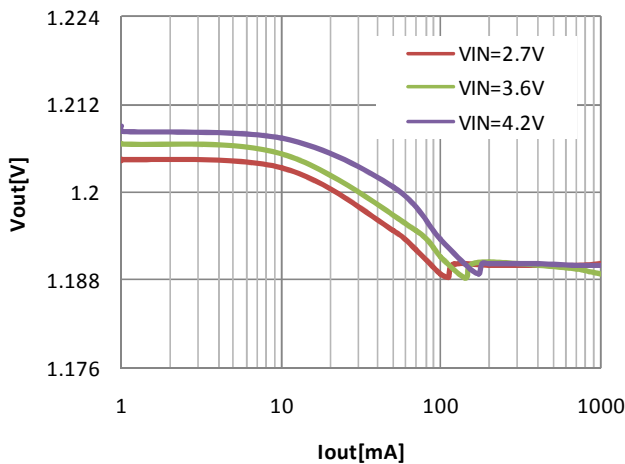

Fig.23 Load regulation  
 PWM/PFM Auto mode

●Electrical characteristic curves (Reference data)  
BU90004GWZ(1.80V OUTPUT)

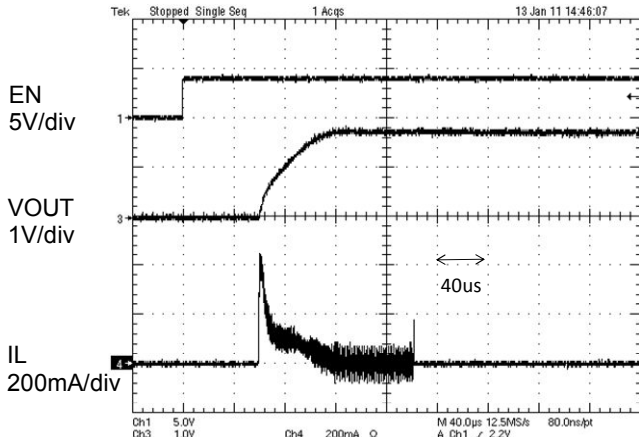

Fig.24 Start up

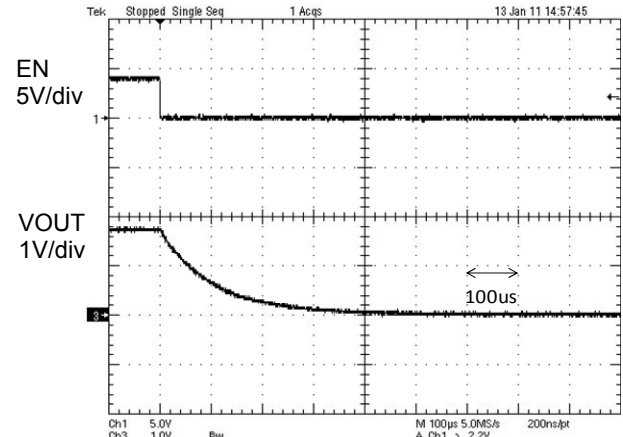

Fig.25 Shut down

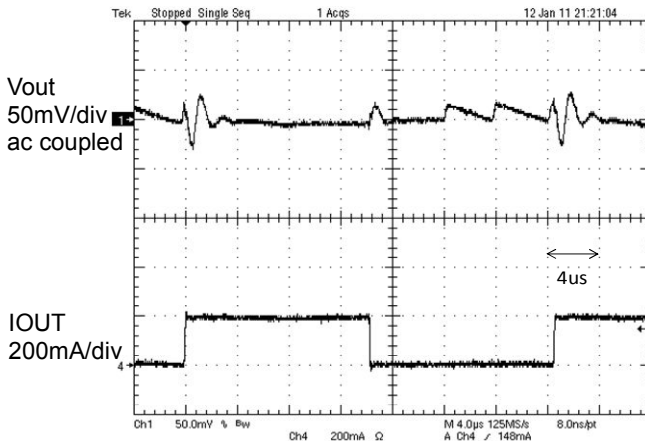

Fig. 26 Load transient response 5mA to 200mA  
tr=tf=100ns, Mode :Low

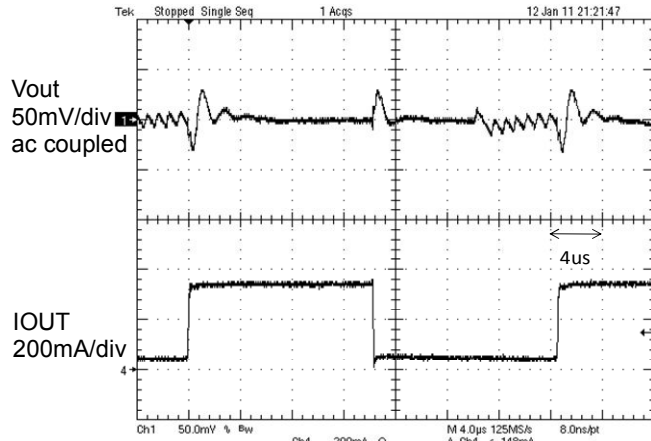

Fig.27 Load transient response 50mA to 350mA  
tr=tf=100ns, Mode :Low

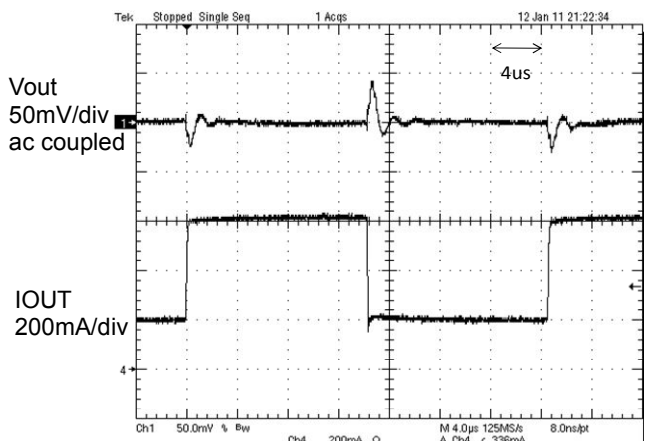

Fig.28 Load transient response 200mA to 600mA  
tr=tf=100ns, Mode :Low

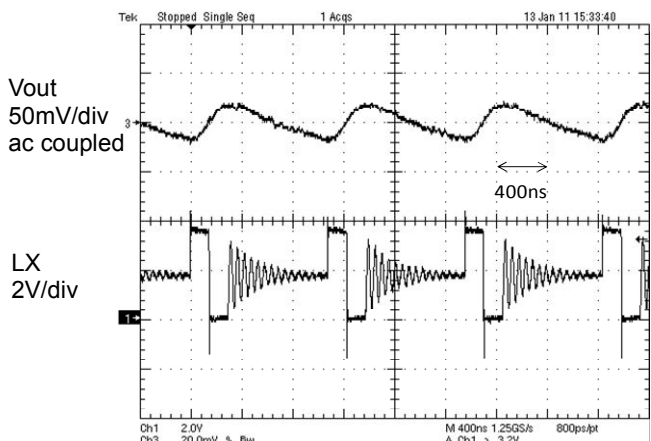

Fig.29 PFM mode Operation Iout=50mA

●Electrical characteristic curves (Reference data) – Continued  
 BU90004GWZ(1.80V OUTPUT)

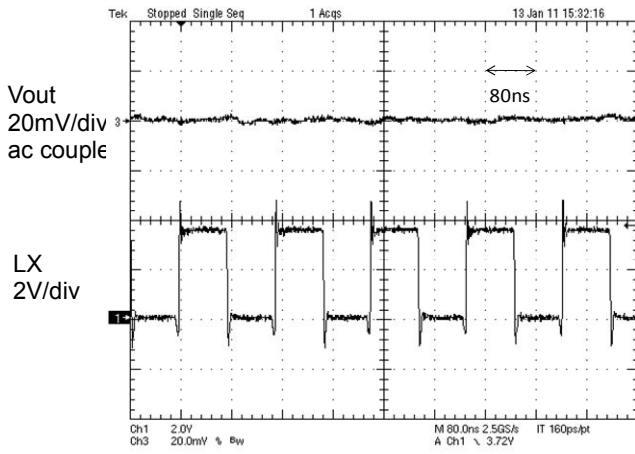

Fig.30 PWM mode Operation Iout=100mA

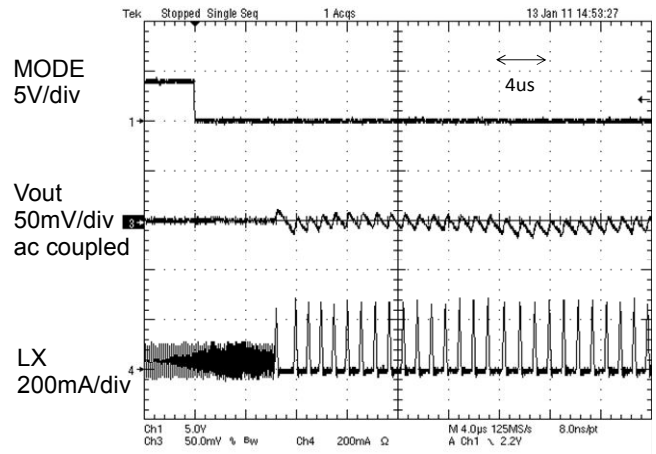

Fig.31 Mode Change Response  
 MODE High to Low

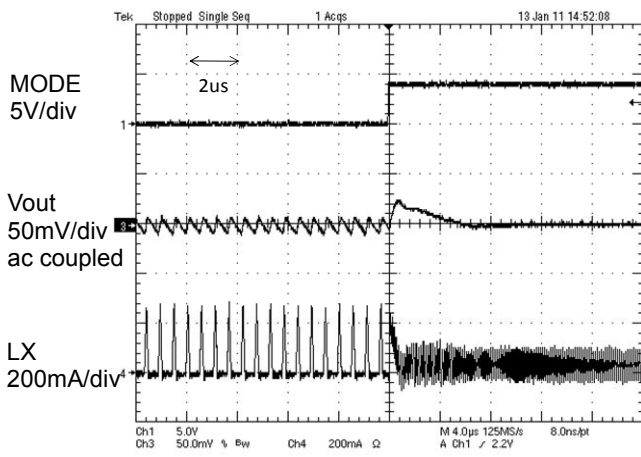

Fig.32 Mode Change Response  
 MODE Low to High

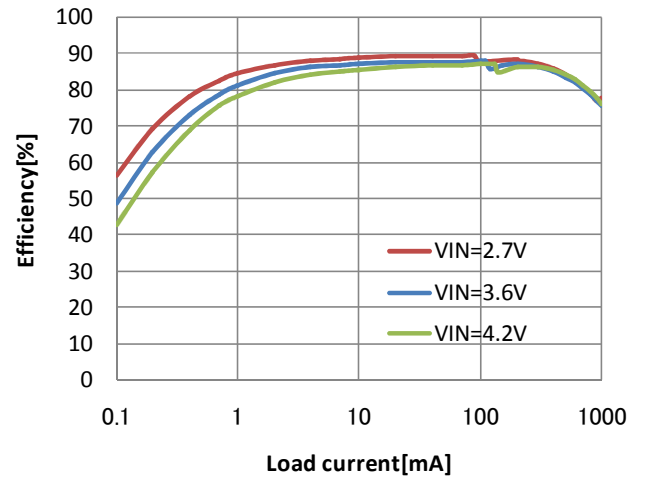

Fig.33 Efficiency vs Load current  
 VIN=3.6V PWM/PFM Auto Mode

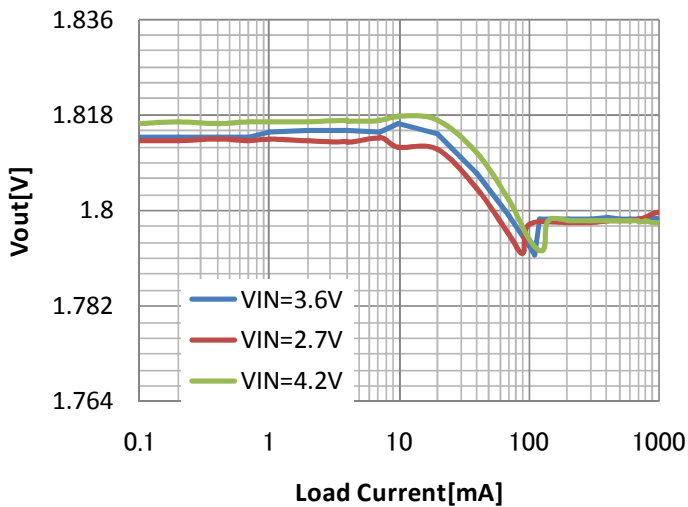
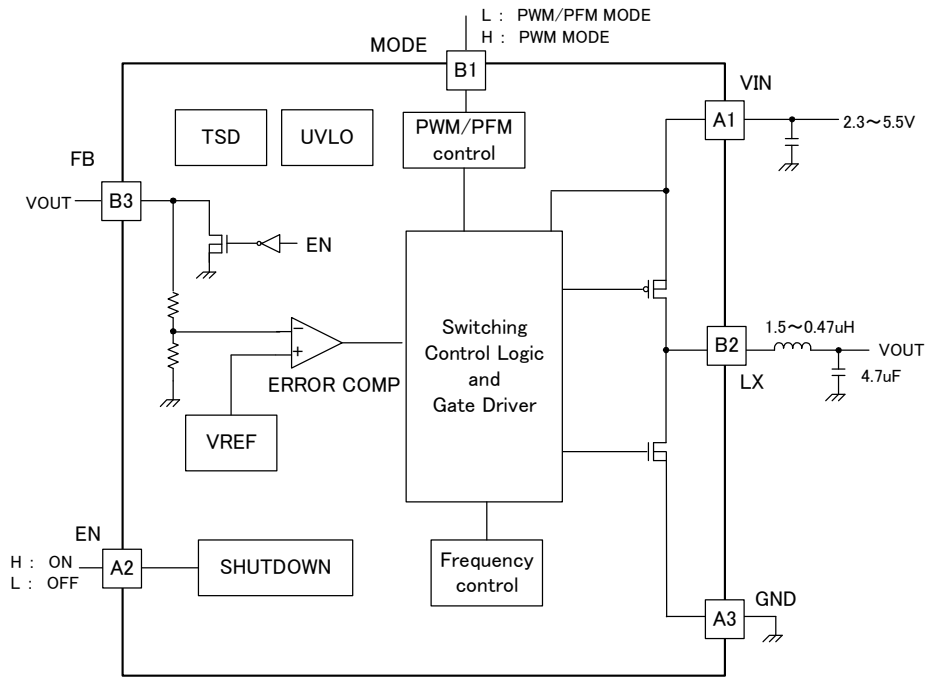

Fig.34 Load regulation  
 PWM/PFM Auto mode



●Block diagram /Application circuit



●External dimensions

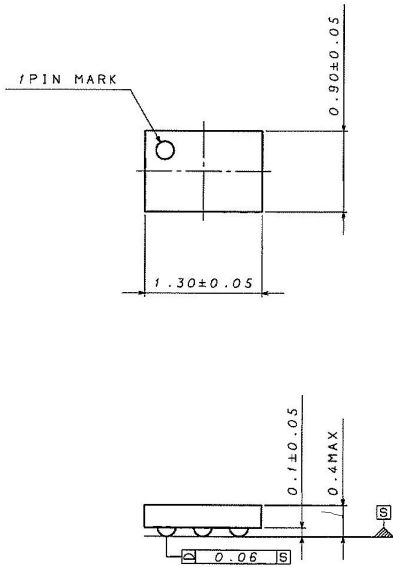

●Pin layout (BOTTOM VIEW)

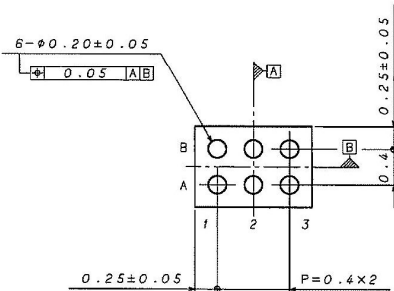
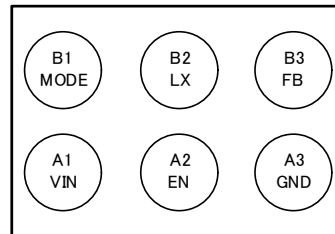

●Pin number/Name/Functions

Pin No.	Name	Function
A1	VIN	Power supply input pin
A2	EN	Enable pin
A3	GND	GND pin
B1	MODE	Forced PWM mode pin
B2	LX	Inductor connection pin
B3	FB	Feedback voltage input pin

(UNIT : mm)

### ● Functional descriptions

The BU9000XGWZ are a synchronous step-down DC/DC converter that achieves fast transient response from light load to heavy load by hysteretic PWM control system and current constant PFM control system.

#### OPWM control

BU9000XGWZ operates by hysteretic PWM control. This scheme ensures fast switching, high efficiency, and fast transient response.

When the output voltage is below the VREF voltage, the error comparator output is low to high and turning on P-channel MOSFET until above the VREF voltage and minimum on time.

#### OPFM control

At light load the regulator and MODE=low, the regulator operates with reduced switching frequency and improves the efficiency. During PFM operation, the output voltage slightly higher than typical output voltage.

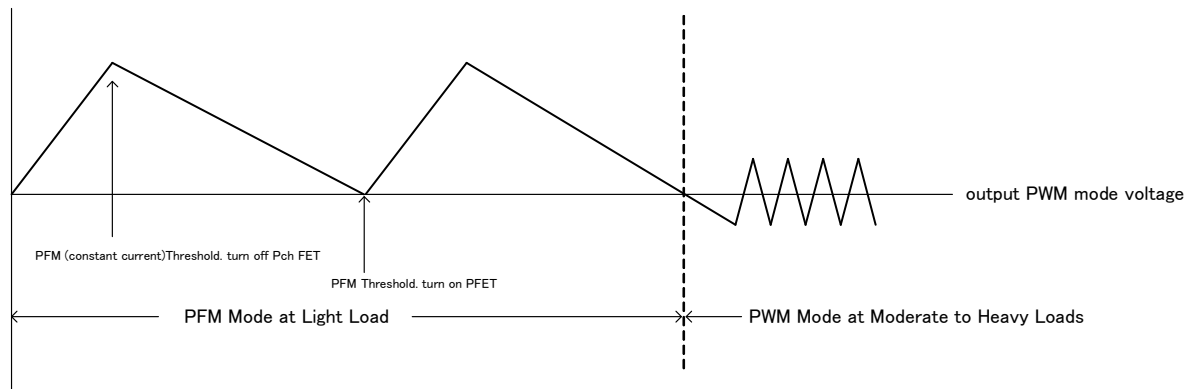

Fig. Operation of PFM mode and PWM mode

## ●Description of operations

## 1) Shutdown

If the EN input pin set to low (<0.4V), all circuit are shut down and the regulator is standby mode.  
Do not leave the EN pin floating.

## 2) Soft start function

The regulator has a soft start circuit that reduces in-rush current at start-up. Typical start up times with a 4.7uF output capacitor is 120usec.

## 3) Current limit

The BU9000XGWZ has a current limit circuit that protects itself and external components during overload condition.

## 4) UVLO

The BU9000XGWZ has a Under Voltage Lock Out circuit that turn off device when  $V_{IN} > 2.05V$ (typ.)

## 5) FORCED PWM MODE

Setting MODE pin high (>1.4V) places the regulator in forced PWM.

## 6) TSD

The BU9000XGWZ has a thermal shutdown feature to protect the device if the junction temperature exceeds 150°C. In thermal shutdown, the DRIVER is disabled.

●PC Board layout

The suggested PCB layout for the BU9000XGWZ are shown in Figure. The following guidelines should be used to ensure a proper layout.

- 1) The input capacitor CIN should be connect as closely possible to VIN pin and GND pin.
- 2) From the output voltage to the FB pin line should be as separate as possible.
- 3) COUT and L should be connected as closely as possible. The connection of L to the LX pin should be as short as possible.

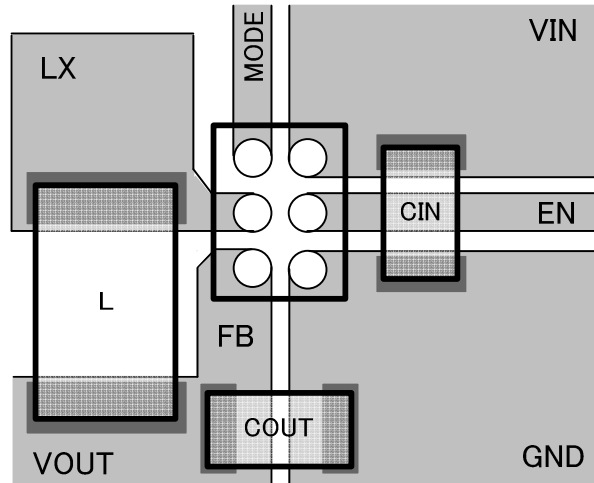

Fig. PCB layout

●External parts selection

1) Inductor selection

The inductance significantly depends on output ripple current. As shown by following equation, the ripple current decreases as the inductor and/or switching frequency increase.

$$\Delta I_L = \frac{(V_{IN} - V_{OUT}) \times V_{OUT}}{L \times V_{IN} \times f}$$

f: switching frequency    L: inductance     $\Delta I_L$ : inductor current ripple

As a minimum requirement, the DC current rating of the inductor should be equal to the maximum load current plus half of the inductor current ripple as shown by the following equation.

$$I_{LPEAK} = I_{OUTMAX} + \frac{\Delta I_L}{2}$$

Recommended inductor selection

- LQM21MPN1R0NG0 (2.0mm × 1.6mm × 1.0mm Murata)     $I_{out} \leq 1A$
- LQM21PN1R0NGC (2.0mm × 1.2mm × 1.0mm Murata)     $I_{out} \leq 0.6A$

2)Recommended input capacitor(CIN) selection

- GRM155R60J225M(1.0mm × 0.5mm × 0.5mm Murata)
- GRM188R60J475ME84(1.6mm × 0.8mm × 0.8mm Murtata)

3)Recommended output capacitor(COUT) selection

- GRM155R60J475M(1.0mm × 0.5mm × 0.5mm Murata)
- GRM155R60G106ME44(1.0mm × 0.5mm × 0.5mm Murata)
- GRM188R60J475ME84(1.6mm × 0.8mm × 0.8mm Murtata)

**● Caution of use**

## 1) Absolute maximum ratings

An excess in the absolute maximum rating, such as supply voltage, temperature range of operating conditions, etc., can break down the devices, thus making impossible to identify breaking mode, such as a short circuit or an open circuit. If any over rated values will expect to exceed the absolute maximum ratings, consider adding circuit protection devices, such as fuses.

## 2) GND voltage

The potential of GND pin must be minimum potential in all condition. As an exception, the circuit design allows voltages up to -0.3 V to be applied to the IC pin.

## 3) Thermal design

Use a thermal design that allows for a sufficient margin in light of the power dissipation (Pd) in actual operating conditions.

## 4) Inter-pin shorts and mounting errors

Use caution when positioning the IC for mounting on printed circuit boards. The IC may be damaged if there is any connection error or if pins are shorted together.

## 5) Actions in strong electromagnetic field

Use caution when using the IC in the presence of a strong electromagnetic field as doing so may cause the IC to malfunction.

## 6) Mutual impedance

Power supply and ground wiring should reflect consideration of the need to lower mutual impedance and minimize ripple as much as possible (by making wiring as short and thick as possible or rejecting ripple by incorporating inductance and capacitance).

## 7) Thermal shutdown Circuit (TSD Circuit)

This model IC has a built-in TSD circuit. This circuit is only to cut off the IC from thermal runaway, and has not been design to protect or guarantee the IC. Therefore, the user should not plan to activate this circuit with continued operation in mind.

## 8) Regarding input pin of the IC

This monolithic IC contains P+ isolation and P substrate layers between adjacent elements in order to keep them isolated.

P-N junctions are formed at the intersection of these P layers with the N layers of other elements, creating a parasitic diode or transistor. For example, as shown in the figures below, the relation between each potential is as follows:

When  $GND > Pin A$  and  $GND > Pin B$ , the P-N junction operates as a parasitic diode.

When  $GND > Pin B$ , the P-N junction operates as a parasitic transistor.

Parasitic diodes can occur inevitable in the structure of the IC. The operation of parasitic diodes can result in mutual interference among circuits, operational faults, or physical damage. Accordingly, methods by which parasitic diodes operate, such as applying a voltage that is lower than the GND (P substrate) voltage to an input pin, should not be used.

●Ordering part number

TBD